

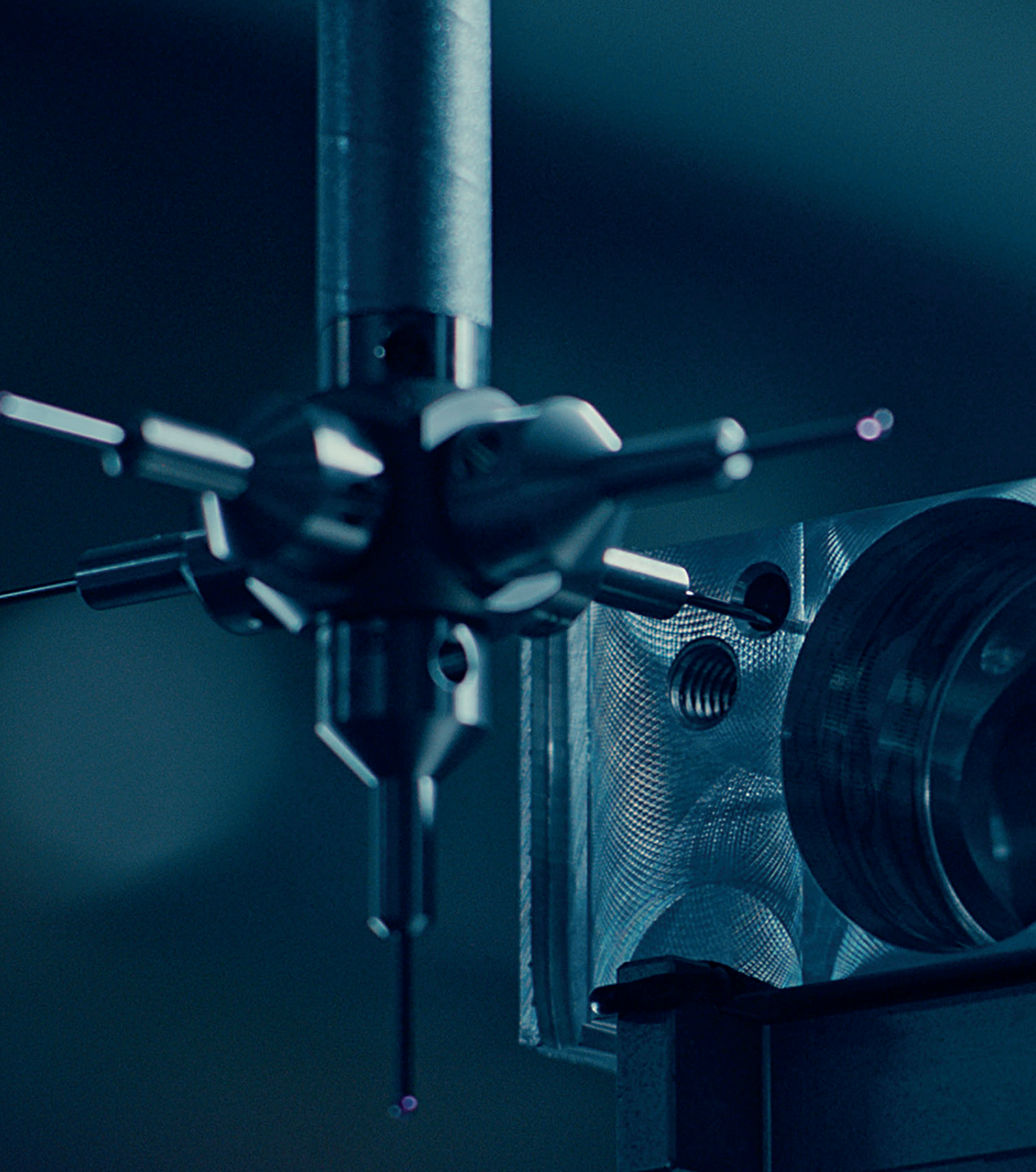

FritsJurgens®



Authorised Distributor :

SIMU VERSAILLES INDONESIA

Panglima Polim Raya 18x, Jakarta 12160, Indonesia
+62 21 7261230

www.selarasindah.com
ig @simu_indonesia

FROM THE NETHERLANDS, FRITSJURGENS CREATES PIVOT HARDWARE SOLUTIONS OF THE HIGHEST POSSIBLE QUALITY THAT EXCEED INDUSTRY STANDARDS AND OUR CLIENT'S EXPECTATIONS. THESE SOLUTIONS ENABLE ENDLESS PIVOT DOOR DESIGN POSSIBILITIES.

- | | |
|--------------------------|--|
| Hidden hardware | Only small floor and ceiling plates are visible.
All the hardware is hidden in the door. |
| Unlimited design | The door can be of any height and made with every type of material, creating unlimited design possibilities. |
| Motion technology | Motion technology puts hydraulic power to use, creating a smooth and controlled door movement. |
| Timeless quality | Built from high-performance materials, the systems are maintenance-free and perform flawlessly. |

CONTINUOUS IMPROVEMENT

FritsJurgens strives for the best quality possible. Every system that leaves the FritsJurgens headquarters is designed, fabricated, and tested with the greatest attention to detail and with only the best quality materials. This enabled us to create maintenance-free hinges: even after 136 years of daily use, the hinge will still function flawlessly.

WORLDWIDE NETWORK

Architects, designers, and door manufacturers worldwide work with FritsJurgens. Our pivot hinges are available through a trusted partner-network in 80+ countries.





BOTTOM PIVOTS

System M+

This adjustable pivot hinge brings Latch Control to ensure proper latching, guaranteed control over the movement of doors from 20 kg to 500 kg, and extra adjustability for the movement of the door.

FUNCTION

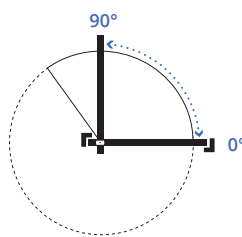
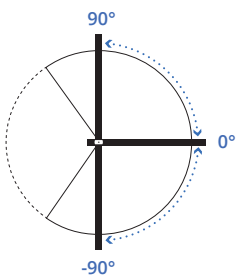

- Double-acting doors
- Rotation 180°
- Hold positions 90°, -90° and 0°
- Self-closing from 125° and -125° to 0°
- Single-acting doors (suitable for doors with latch)
- Rotation 90°
- Hold positions 90° and 0°
- Self-closing from 125° to 0°

MOVEMENT

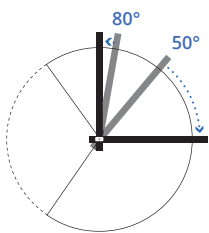

Damper Control

Hydraulic backcheck (opening damping) for wall-protection, and soft-close.

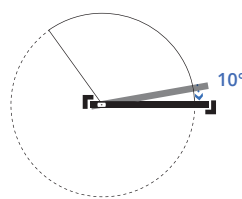

Latch Control

Accelerates the door shortly before closed position to ensure proper latching.

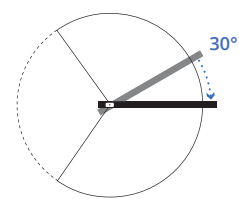

30° Speed Control

Determines the closing speed, the last part of the door's movement.



VARIANTS

SYSTEM M+ (32 MM)

WEIGHT OF THE DOOR*

- Class A: 20 - 119 kg
- Class B: up to 159 kg
- Class C: up to 209 kg
- Class D: up to 279 kg
- Class E: up to 349 kg

* Depending on door width.
See FritsJurgens Selector.

70 MM

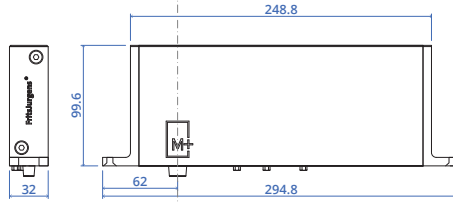

40 MM

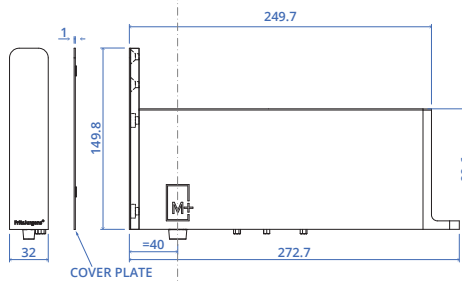

SYSTEM M+ (42 MM)

WEIGHT OF THE DOOR*

- Class F: up to 429 kg
- Class G: up to 500 kg

* Depending on door width.
See FritsJurgens Selector.

70 MM

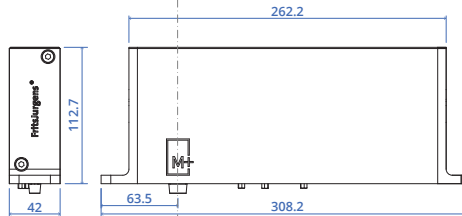

40 MM

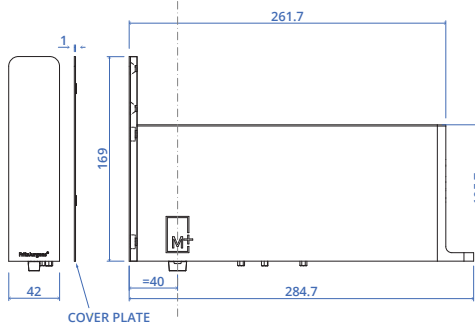

Scan the QR code to discover System M+.



Designed by Studio Ilk
Manufactured by Lane Group Construction & Design
Photographed by Anjie Blair

System M

This self-closing pivot hinge allows you to finetune the movement of your door, while easily carrying a broad range of pivot door types up to 209 kg.

FUNCTION

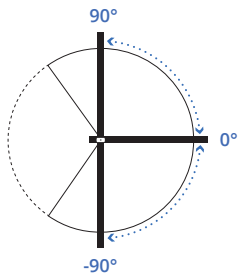

- Double-acting doors
- Rotation 180°
- Hold positions 90°, -90° and 0°
- Self-closing from 125° and -125° to 0°

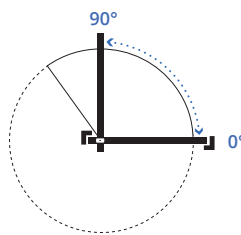

- Rotation 90°
- Hold positions 90° and 0°
- Self-closing from 125° to 0°

MOVEMENT

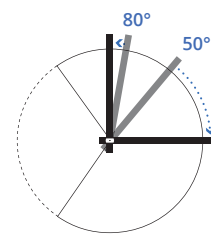

Damper Control

Hydraulic backcheck (opening damping) for wall-protection, and soft-close.

VARIANTS

WEIGHT OF THE DOOR*

- Class AA: 20 - 79 kg
- Class A: up to 119 kg
- Class B: up to 159 kg
- Class C: up to 209 kg

* Depending on door width.
See FritsJurgens Selector.

70 MM

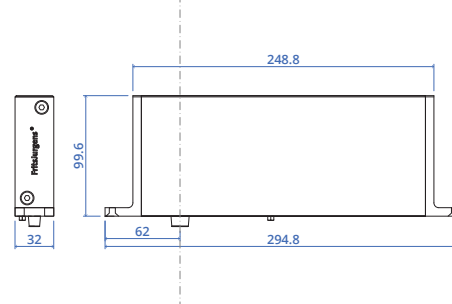

40 MM

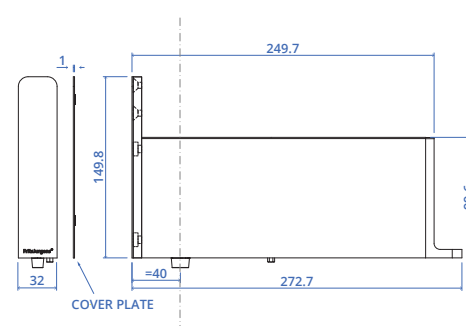

Scan the QR code to discover System M.



Designed by Atelier Air concept
Manufactured by Air-Lux Technik AG
Photographed by Lukas Hausenblas

System One

The most ideal pivot hinge for narrow profile doors. With a height of just 18 mm, this pivot hinge can be applied in a broad range of pivot door designs and applications.

FUNCTION

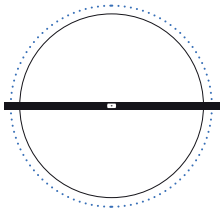

- Double-acting doors
- Rotation 360°

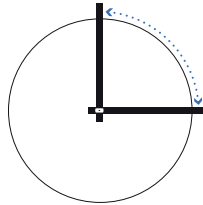

- Single-acting doors
- Rotation 90°

MOVEMENT

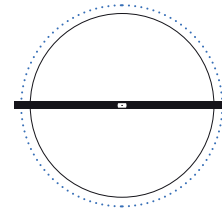

- 360° free-swinging pivot

VARIANTS

WEIGHT OF THE DOOR

Class G: 0 - 500 kg

70 MM

Pivot point at least 70 mm from the edge of the door.

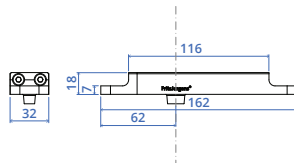

40 MM

Pivot position at 40 mm from the edge of the door.

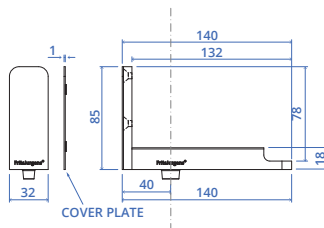

Scan the QR code to discover System One.



System 3

This 360° rotating pivot hinge has various hold positions, and is ideal for pivoting walls.

FUNCTION

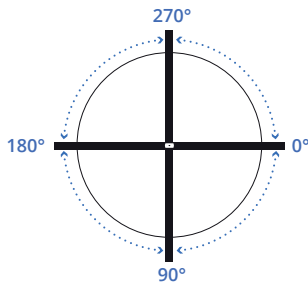

- Double-acting doors/walls
- Rotation 360°
- Hold positions 0°, 90°, 180°, 270°

MOVEMENT

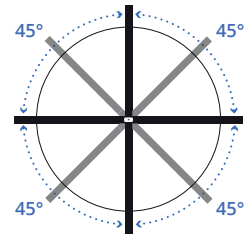

Below each 45° angle, the door automatically moves from both directions to the hold position.

VARIANTS

WEIGHT OF THE DOOR*

- Class AA: 20 - 79 kg
- Class C: up to 249 kg
- Class E: up to 349 kg
- Class G: up to 350 kg

* Depending on door width.
See FritsJurgens Selector.

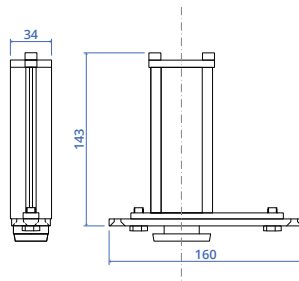

Scan the QR code to discover System 3.



TOP PIVOTS

Top pivot 40 mm

Compatible with: System M+, System M, System One

- Fixed pivot point at 40 mm
- Maximum clear width, minimal unused space
- Pivot door is minimally present in open position
- Ideal for situations with standard door widths

Available in two options

- Top pivot class B (10 mm pin): For System M and System M+ (classes AA, A and B)
- Top pivot class G (15 mm pin): For System M, System M+ (classes C, D, E, F, G) and for System One (class G)

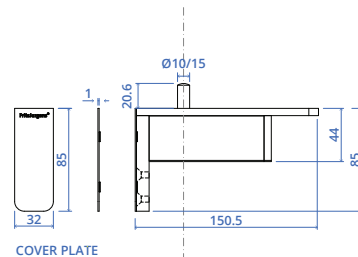

Top pivot 70 mm

Compatible with: System M+, System M, System One, System 3

- Pivot point from 70 mm to middle placement
- All-rounder: suitable for almost every pivot door and situation

Available in two options

- Top pivot class B (10 mm pin): For System M, System M+ and System 3 (classes AA, A and B)
- Top pivot class G (15 mm pin): For System M, System M+, System 3 (classes C, D, E, F, G) and System One

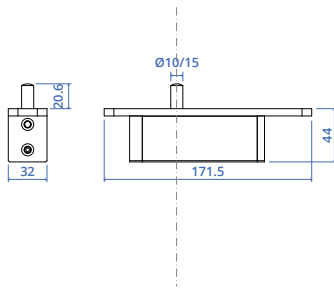



Designed by PHD Group Australias
Manufactured by BAU Group Construction
Photographed by The picture desk (Des Harris)

Top pivot Cable Grommet

Compatible with: System M+, System M,
System One, System 3

- Pivot point from 91 mm to middle placement
- Designed to easily lead cables through the top pivot
- 8 mm hole in the pin for cables

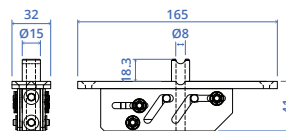



Designed by Kwint and Bulder interieurarchitect
Manufactured by Harryvan Interieur

Top pivot Reversed

Compatible with: System M+, System M,
System One, System 3

- Pivot point from 130 mm to middle placement
- Ideal for extra thin door frames and/or large glass openings
- Installation in the top jamb

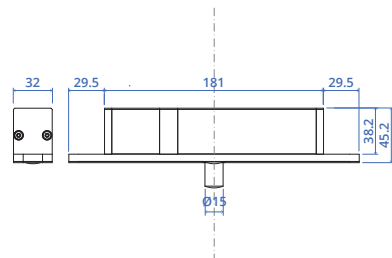

HINGE PLATES

Floor plates

FOR SYSTEM M/M+



Floor plate squared*
Stainless steel



Floor plate squared*
Black



Floor plate round
Stainless steel



Floor plate round
Black



Floor plate Flush rounded
Sunk into door frame or floor, so flush with surrounding area. Ideal for drop seals.



Floor plate Flush squared
Sunk into door frame or floor, so flush with surrounding area. Ideal for drop seals.

FOR SYSTEM 3



Floor plate squared
Stainless steel



Floor plate round
Stainless steel

* Package includes extra mounting pins (two long and two short) for different floor types.

FOR SYSTEM ONE



**Floor plate squared NA*
(non-adjustable)**
Stainless steel



Floor plate squared*
Black



Floor plate round
Stainless steel



Floor plate round
Black



Floor plate Flush rounded
Sunk into door frame or floor, so flush with surrounding area. Ideal for drop seals.



Floor plate Flush squared
Sunk into door frame or floor, so flush with surrounding area. Ideal for drop seals.

GREAT SOLUTION FOR PROJECTS WITH RADIANT FLOOR HEATING

FritsJurgens' pivot hinge systems all rest on a small floor plate that distributes the door's force evenly into the floor. The floor plates can all be mortised with 8 mm mounting pins. This means that they form an ideal solution in combination with radiant floor heating.

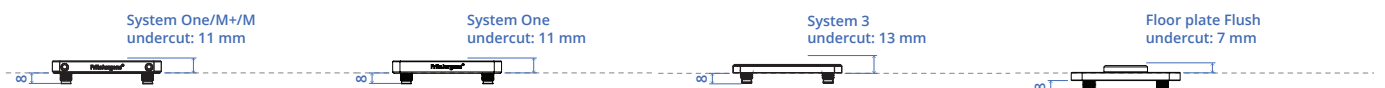

Ceiling plates

CLASS B



Ceiling plate Class B
Black
10 mm pin



Ceiling plate Class B
Stainless steel
10 mm pin



CLASS G



Ceiling plate Class G
Black
15 mm pin



Ceiling plate Class G
Stainless steel
15 mm pin



Receiver

FOR TOP PIVOT REVERSED

When ordering the top pivot Reversed, a rectangular Receiver is included in the set. The Receiver is mounted inside the top of the pivot door. The pin of the top pivot Reversed is rotated downwards into the Receiver during the installation.

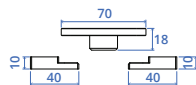

Cover plates

SYSTEM M+/M 40 MM BOTTOM AND TOP PIVOTS



SS
Stainless steel
(plates and pivot covers)



BK
Black
(plates and pivot covers)



SS BK
Stainless steel plates
Black pivot covers



BK SS
Black plates
Stainless steel covers

TOP PIVOT REVERSED



SS
Stainless steel cover plate



BK
Black cover plate



WT
White cover plate

SYSTEM ONE 40 MM



SS
Stainless steel cover plate



BK
Black cover plate

ACCESSORIES

Flush

The Flush consists of two strong magnets. These are mounted in the bottom side of the pivot door and the adjacent wall. The Flush hereby strengthens the 0° position of every pivot door, regardless its size or weight.



Hexagon Guide

The Hexagon Guide can ease the installation of the pivot door. The minimum distance from the pivot point to the edge of the door is 70 mm and the maximum distance is the middle of the door width. In case the pivot point is more than 280 mm from the edge of the door we offer the Hexagon Guide to ease the installation.



Axle Wrench

When installing a door fitted with System M+ or System M, it is very important that the door is installed in its open position. This can be accomplished by using the Axle Wrench to rotate the oval spindle in the bottom of the system 90°, pointing the arrow toward the direction the door will be opening (0° position). In case of frequent use, it is possible to mount the floor plate (art. FPM.X.X.S.SS) on the Axle Wrench.



Adapters

The Adapters can be used to mount the components in a metal profile. The two Adapters are mounted in the profile first. They then offer a solid base to mount the component on. We currently offer Adapters for 2 mm thick profiles only. This product is compatible with all top pivots, and with bottom pivots System One and System 3.



	SYSTEM M+	SYSTEM M	SYSTEM 3	SYSTEM ONE
FEATURES				
Rotation	180° rotation and 90° rotation with door frames	180° rotation and 90° rotation with door frames	360° rotation	360° and 90° rotation
Hold position	90°, -90° and 0°	90°, -90° and 0°	0°, 90°, 180° and 270°	-
Free swing	-	-	-	✓
Self-closing	✓	✓	-	-
For double acting doors	✓	✓	✓	✓
For single acting doors	✓	-	-	✓
For door frames/jambs	✓	-	-	✓
Door weight	20 - 500 kg*	20 - 209 kg*	20 - 350 kg*	0 - 500 kg
MOVEMENT ADJUSTABILITY				
Damper Control	✓	✓	-	-
30° Speed Control	✓	-	-	-
Latch Control	✓	-	-	-
SPECIFICATIONS				
Weight classes	7 classes, A-G	4 classes, AA-C	4 classes, AA, C, E & G	1 class, G
Weight	Class A-E: 2.7 kg Class F-G: 4.0 kg	Class A-E: 2.7 kg Class F-G: 4.0 kg	0.74 kg	0.22 kg
Material	Stainless steel Anodized Aluminum	Stainless steel Anodized Aluminum	Stainless steel Anodized Aluminum	Stainless steel Anodized Aluminum
TOP PIVOT COMPATIBILITY				
Top pivot	TP-70, TP-40, TP-CG, TP-R	TP-70, TP-40, TP-CG, TP-R	TP-70, TP-CG, TP-R	TP-70, TP-40, TP-CG, TP-R

* Depending on door width. See FritsJurgens Selector.

FritsJurgens®

FRITSJURGENS INTERNATIONAL

A. Einsteinlaan 1
9615 TE Kolham
The Netherlands
+31 598 343 410
info@fritsjurgens.com

Indonesia Authorised Distributor :

SIMU VERSAILLES INDONESIA

Panglima Polim Raya 18x, Jakarta 12160,
Indonesia +62 21 7261230

www.selarasindah.com
ig @simu_indonesia

FRITSJURGENS ITALIA (REGIONAL SALES OFFICE)

Via Marsilio Ficino 22
50132 Firenze
Italy
+39 055 064 0290
info@fritsjurgens.com

FRITSJURGENS DUBAI BRANCH

DLC-OP-A2-4-0029
Dubai South
Dubai
United Arab Emirates

BO.info.EN.2023

Copyright © FritsJurgens®

05-2023



8 720681 608389



www.fritsjurgens.com