



FritsJurgens®



ESTABLISHED IN THE NETHERLANDS, FRITSJURGENS WAS FOUNDED TO CREATE PIVOT DOOR SOLUTIONS THAT MAKE SMALL TO MONUMENTAL AND SIMPLE TO EXPERIMENTAL DOORS POSSIBLE.

Hidden perfection - Only a small floor and ceiling plates are visible and the remaining hardware are all hidden.

Unlimited design - The door can be of any height and made of any material giving unlimited design possibilities.

Motion technology - Motion technology puts hydraulic power to use by turning it into a controlled and smooth door movement.

Timeless quality - Built from high-performance materials, the systems are maintenance-free and perform flawlessly.

CONTINUOUS IMPROVEMENT

FritsJurgens strives for the best quality possible. Every system that leaves the FritsJurgens headquarters is designed, fabricated, and tested with the greatest attention to detail and with only the best quality materials. This enabled us to create maintenance-free hinges: even after 136 years of daily use, the hinge will still function flawlessly.

GLOBAL PRESENCE

We cater to customers across the globe and we have a distribution network in over 80 countries.





SYSTEM M+

This adjustable pivot hinge brings Latch Control to ensure proper latching, guaranteed control over the movement of doors from 20 kg to 500 kg, and extra adjustability for the movement of the door.

FUNCTION

Double-acting doors

Rotation 180°

Hold positions 90°, -90° and 0°

Self-closing from 125° and

-125° to 0°

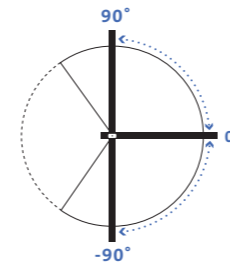

Single-acting doors

Rotation 90°

Hold positions 90° and 0°

Self-closing from 125° to 0°

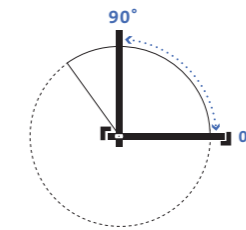

MOVEMENT

Adjustable Back-check/Damper

Back-check for damping on opening and soft-close.

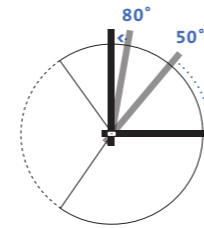

Adjustable 30° Speed

Adjustable closing speed in last part of closing movement.

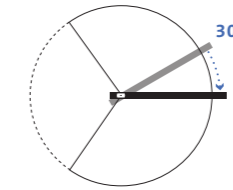

Adjustable Latching Speed

Accelerates the door shortly before closed position to ensure proper latching.

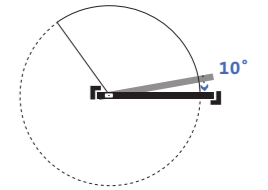

VARIANTS

M32+

70 mm

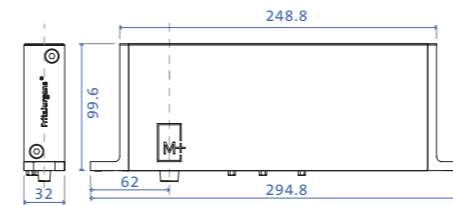

Class A | 80 kg to 119 kg* door

Class B | 120 kg to 159 kg* door

Class C | 160 kg to 209 kg* door

Class D | 210 kg to 279 kg* door

40 mm

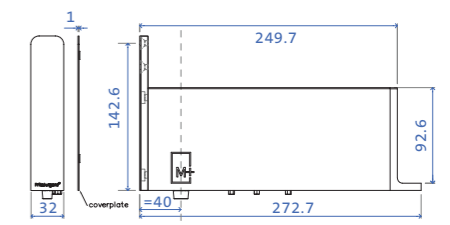

Class E | 280 kg to 349 kg* door

M42+

70 mm

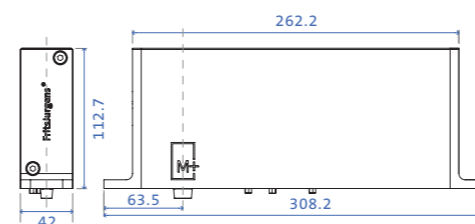

Class F | 350 kg to 429 kg* door

Class G | 430 kg to 500 kg* door

40 mm

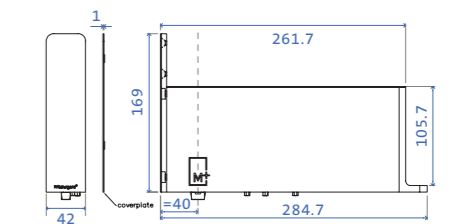

To visit System M+ page,
scan the QR code or [click here](#)

*Depending on door width



SYSTEM M

This self-closing pivot hinge offers you absolute control over the movement of your pivot door. With just the touch of a finger, the pivot door is set into a single fluid motion. Opening the door is effortless and controlled, the movement elegant and the closing as soft as a whisper.

FUNCTION

Double-acting doors

Rotation 180°

Hold positions 90°, -90° and 0°

Self-closing from 125° and
-125° to 0°

Single-acting doors

Rotation 90°

Hold positions 90° and 0°

Self-closing from 125° to 0°

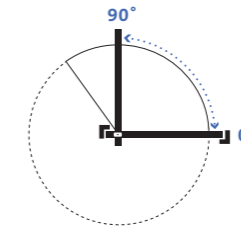
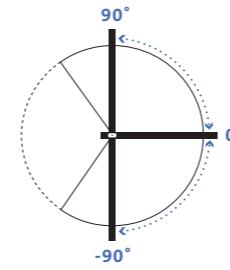

MOVEMENT

Adjustable Damper Control

Back-check for damping on
opening and soft-close.

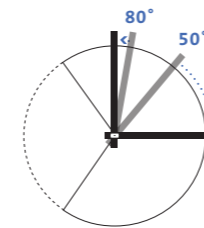

VARIANTS

70 mm

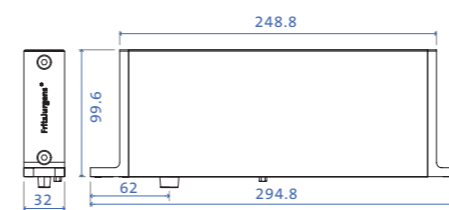

40 mm

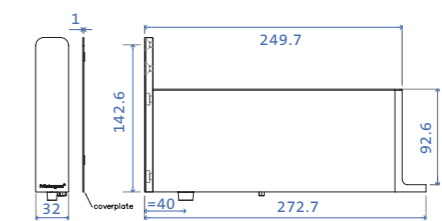

Class AA | 20 kg to 79 kg* door

Class B | 120 kg to 159 kg* door

Class A | 80 kg to 119 kg* door

Class C | 160 kg to 209 kg* door



To visit System M page,
scan the QR code or [click here](#)

*Depending on door width



SYSTEM 3

This is a 360° rotating pivot system with various hold positions, ideal for pivoting walls.

FUNCTION

Double-acting doors

Rotation 360°

Hold positions 0°, 90°, 180°, 270°

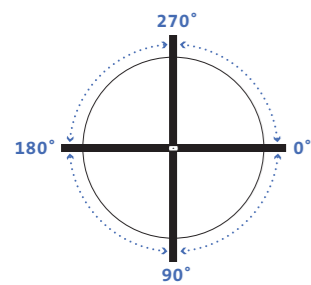

MOVEMENT

Door moves from each

45° angle, in both directions,

to a hold position.

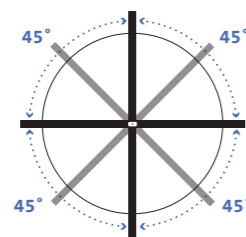

VARIANTS

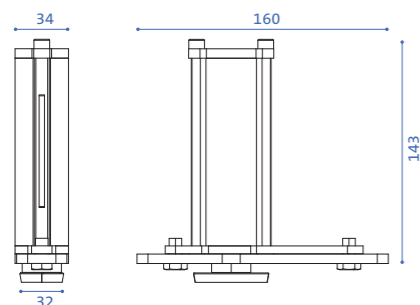

- Class A | 80 kg to 119 kg* door
- Class C | 160 kg to 209 kg* door
- Class E | 280 kg to 349 kg* door
- Class G | 430 kg to 500 kg* door

*Depending on door width

To visit System 3 page,
scan the QR code or [click here](#)



SYSTEM ONE

The most compact pivot hinge with a single pivot point, offering a free-swing pivot door.

FUNCTION

Double-acting doors

Rotation 360°

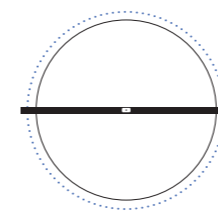

MOVEMENT

360° free-swinging pivot

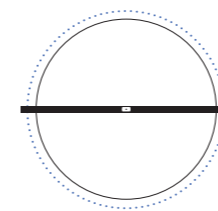

Single-acting doors

Rotation 90°

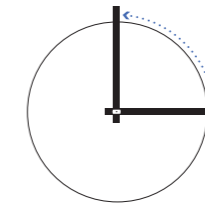

VARIANTS

Only one type

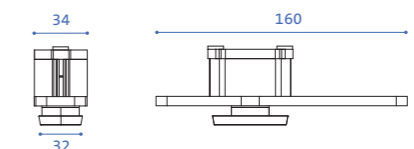

To visit System One page,
scan the QR code or [click here](#)





TOP PIVOTS

A pivot hinge system by FritsJurgens consists of a pivot hinge in the bottom of the door and a top pivot in the top of the door. The top pivot is the top side of the pivot point and anchors the pivot door in the ceiling leaving just a gap of 4 mm to 10 mm.

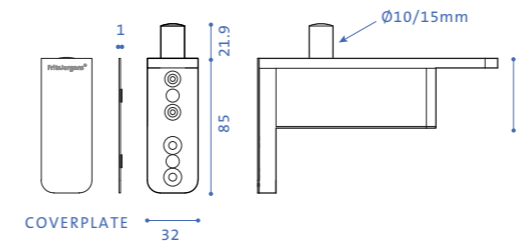

TOP PIVOT 40

SUITABLE FOR: SYSTEM M, SYSTEM M+

Fixed pivot point at 40 mm

Maximum clear width and hardly any unused space

Pivot door is minimally present in open position

Ideal for construction and renovation with standard widths

ADA-compliant pivot doors

Available in two options:

10 mm pin for doors up to 150 kg

15 mm pin for doors between 150 kg and 500 kg

TOP PIVOT 70

SUITABLE FOR: SYSTEM ONE, SYSTEM 3, SYSTEM M, SYSTEM M+

Pivot point from 70 mm to middle placement

All-rounder: suitable for almost every pivot door and situation

ADA-compliant pivot doors

Available in two options:

10 mm pin for doors up to 150 kg

15 mm pin for doors between 150 kg and 500 kg

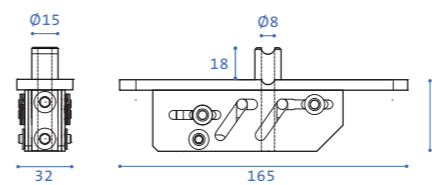
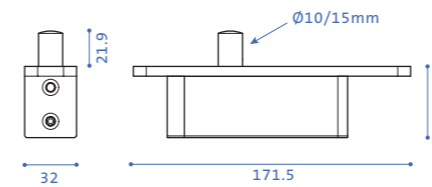

TOP PIVOT CABLE GROMMET

SUITABLE FOR: SYSTEM ONE, SYSTEM 3, SYSTEM M, SYSTEM M+

Pivot point from 91 mm to middle placement

Designed to easily lead cables through the top pivot

To visit top pivots page, scan the QR code or [click here](#)



HINGE PLATES

FLOOR PLATES



Floor plate square
System M/M+
Stainless Steel



Floor plate square
System M/M+
Black



Floor plate Flush rounded
System M/M+
Sinking in frame



Floor plate square
System One/3
Stainless Steel



Floor plate round
System M/M+
Stainless Steel



Floor plate round
System M/M+
Black



Floor plate Flush squared
System M/M+
Sinking in frame



Floor plate round
System One/3
Stainless Steel

Great solution for projects with radiant floor heating

The floor plate fasteners only need to be mortised 8 mm into the floor, which means every FritsJurgens system can also be utilized in combination with radiant floor heating.

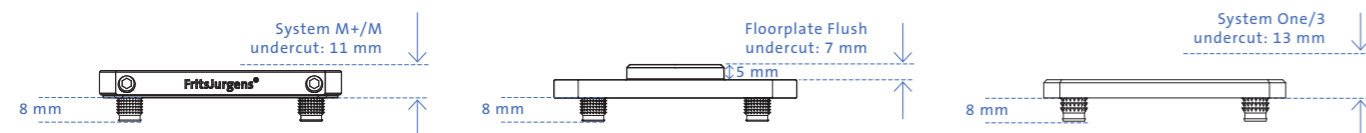

CEILING PLATES



Ceiling plate Class B
Black
10 mm pin



Ceiling plate Class B
Stainless Steel
10 mm pin



Ceiling plate Class G
Black
15 mm pin



Ceiling plate Class G
Stainless Steel
15 mm pin

COVER PLATES

SS

Stainless steel
(plates and pivot covers)

BK

Black
(plates and pivot covers)

SS BK

Stainless steel plates
Black pivot covers

BK SS

Black plates
Stainless steel covers



*Cover plates are only available for System M+/M 40 mm bottom and top pivots.

ACCESSORIES

FLUSH

The Flush consists of two strong magnets. These are mounted in the bottom side of the pivot door and the adjacent wall. The Flush hereby strengthens the 0° position of every pivot door, regardless its size or weight.



HEXAGON GUIDE

The Hexagon Guide can ease the installation of the pivot door. The minimum distance from the pivot point to the edge of the door is 70 mm and the maximum distance is the middle of the door width. In case the pivot point is more than 280 mm from the edge of the door we offer the Hexagon Guide to ease the installation.



AXEL WRENCH

When installing a door fitted with System M, it is very important that the door is installed in its open position. This can be accomplished by using the Axle Wrench to rotate the oval spindle in the bottom of the System M 90°, pointing the arrow toward the direction the door will be opening (0° position). In case of frequent use, it is possible to mount the floor plate (art. FP.M.X.X.S.SS) on the Axle Wrench.



PRODUCT SELECTOR

1 Select hinge placement

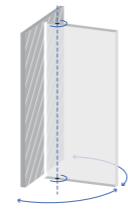

SIDE PLACEMENT

Compatible systems:
System One
System M
System M+

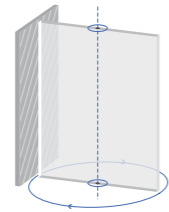

MIDDLE PLACEMENT

Compatible systems:
System One
System 3

2 Select the desired function

Free swing - System One
Hold positions - System 3
Damper Control - System M, System M+
30° Speed Control - System M+
Latch Control - System M+

3 Discover top pivot

Standard top pivot (70 mm) - System One, System 3,
System M & System M+
Maximum clear width (40 mm) - System M & System M+
Cable Grommet (91 mm) - System One, System 3,
System M & System M+

4 Discover bottom pivot and its class based on:

Door width
Pivot point
Door weight

5 Select hinge plate

Select application type
Surface mounted (all bottom systems)
Flush mounted (System M & System M+)
Select the shape type: square or round (all bottom systems)
Select the finish
Stainless steel (all bottom systems)
Black (System M & System M+)

6 Select accessories

Flush - Stainless steel or black
Axle Wrench - System M
Hexagon Guide - 1 m or 2 m

	SYSTEM M+	SYSTEM M	SYSTEM 3	SYSTEM ONE
FEATURES				
Rotation	180° rotation and 90° rotation with door frames	180° and 90° rotation	360° rotation	360° and 90° rotation
Hold position	90°, -90° and 0°	90°, -90° and 0°	0°, 90°, 180° and 270°	-
Free swing	•	-	•	•
Self-closing	•	•	-	-
Double acting	•	•	•	•
Single acting	•	•	-	•
Door frames/jamb	•	-	-	•
Door weight	20 - 500 kg*	20 - 210 kg*	20 - 500 kg*	0 - 500 kg*
Door Acting	Double Acting Single Acting	Double Acting Single Acting	Double Acting	Double Acting Single Acting
MOVEMENT ADJUSTABILITY				
Damper Control	•	•	-	-
30° Speed Control	•	-	-	-
Latch Control	•	-	-	-
SPECIFICATIONS				
Weight classes	7 classes, A-G	4 classes, AA-C	4 classes, A,C,E and G	1 Class, O
Weight	M32+: 2,6 kg M42+: 3,6 kg	2,6 kg	0,75 kg	0,36 kg
Dimensions	M32+: 284,8 x 32 x 99,6 mm M42+: 308,2 x 42 x 112,7 mm	294,8 x 32 x 99,6 mm	160 x 32 x 143 mm	160 x 32 x 39 mm
Material	Stainless Steel Anodized Aluminum	Stainless Steel Anodized Aluminum	Stainless Steel Anodized Aluminum	Stainless Steel Anodized Aluminum

*Depending on door width



To visit selector page,
scan the QR code or [click here](#)

FritsJurgens®

FRITSJURGENS INTERNATIONAL

A. Einsteinlaan 1
9615 TE Kolham
The Netherlands
+31 598 343 410
info@fritsjurgens.com

FRITSJURGENS ITALY (Regional sales office)

Via Marsilio Ficino 22
50132 Firenze
Italy
+39 055 064 0290
info@fritsjurgens.com

FRITSJURGENS CHINA (Regional sales office)

上海市长寿路360号源达大厦1508室
360 Changshou Road, Room 1508, Shanghai
China
+86 138 1692 5021

FRITSJURGENS CONSULTING FZE (Regional sales office)

Premises No. HD67
Floor 25
Sheikh Rashid Tower
Dubai World Trade Centre
Dubai, UAE

BO.info.EN.2022
Copyright © FritsJurgens®
07-04-2022

Authorised Distributor :

SIMU VERSAILLES INDONESIA

Panglima Polim Raya 18x, Jakarta 12160,
Indonesia +62 21 7261230

www.selarasindah.com
ig @simu_indonesia

